

MEASUREMENT REPORT

EN 301 893 V2.1.1 WLAN 802.11a/n/ac

Applicant: Compex Systems Pte Ltd

Address: No:9 Harrison Road, Harrison Industrial Building, #05-01,
Singapore 369651

Product: 802.11ac Dual Band Module

Model No.: WLE600VX, WLE600VX-I

Brand Name: COMPEX

Standards: ETSI EN 301 893 V2.1.1 (2017-05)

Result: Complies

Test Date: June 20 ~ July 11, 2017

Reviewed By : *Jame Yuan*
(Jame Yuan)

Approved By : *Marlin Chen*
(Marlin Chen)



The test results relate only to the samples tested.

The test results shown in the test report are traceable to the national/international standards through the calibration of the equipment and evaluated measurement uncertainty herein.

The test report shall not be reproduced except in full without the written approval of MRT Technology (Suzhou) Co., Ltd.

Revision History

Report No.	Version	Description	Issue Date	Note
1706RSU02403	Rev. 01	Initial report	07-11-2017	Valid

Note: This test report was based on MRT report number 1612RSU02402 and updated the standard EN 301893 version from v1.8.1 to v2.1.1. Besides adaptivity & the receiver blocking items, there is no any other updated item.

CONTENTS

Description	Page
1. General Information.....	4
1.1. Applicant.....	4
1.2. Manufacturer	4
1.3. Testing Facility	4
1.4. Feature of Equipment under Test.....	5
1.5. Product Specification Subjective	5
1.6. Operation Frequency / Channel List	5
1.7. Description of Available Antennas.....	6
1.8. Standards Applicable for Testing	6
1.9. Application Form for Testing.....	7
2. Test Summary.....	9
3. Adaptivity (Channel Access Mechanism).....	10
3.1. Limit.....	10
3.2. Test Setup	11
3.3. Test Procedure	11
3.4. Test Result.....	12
4. Receiver Blocking... ..	18
4.1. Limit.....	18
4.2. Test Setup	18
4.3. Test Procedure	18
4.4. Test Result.....	19
5. Measurement Uncertainty	21
6. List of Measuring Instrument.....	22

1. General Information

1.1. Applicant

Compex Systems Pte Ltd

No:9 Harrison Road, Harrison Industrial Building, #05-01, Singapore 369651

1.2. Manufacturer

Compex Systems Pte Ltd

No:9 Harrison Road, Harrison Industrial Building, #05-01, Singapore 369651

1.3. Testing Facility

Test Site

MRT Technology (Suzhou) Co., Ltd

Test Site Location

D8 Building, No.2 Tian'edang Rd., Wuzhong Economic Development Zone, Suzhou, China

Test Facility / Accreditations

Measurements were performed at MRT Laboratory located in Tian'edang Rd., Suzhou, China

- MRT facility is a FCC registered (MRT Reg. No. 809388) test facility with the site description report on file and has met all the requirements specified in Section 2.948 of the FCC Rules.
- MRT facility is an IC registered (MRT Reg. No. 11384A-1) test laboratory with the site description on file at Industry Canada.
- MRT facility is a VCCI registered (R-4179, G-814, C-4664, T-2206) test laboratory with the site description on file at VCCI Council.
- MRT Lab is accredited to ISO 17025 by the American Association for Laboratory Accreditation (A2LA) under the American Association for Laboratory Accreditation Program (A2LA Cert. No. 3628.01) in EMC, Telecommunications and Radio testing for FCC, Industry Canada, EU and TELEC Rules.



1.4. Feature of Equipment under Test

Product Name:	802.11ac Dual Band Module
Serial Model:	WLE600VX, WLE600VX-I
Brand Name:	COMPEX
Wi-Fi Specification:	802.11a/b/g/n/ac

Note: Differences between all models are for different marketing requirement.

1.5. Product Specification Subjective

Frequency Range	For 802.11a/n-HT20 5180~5240 MHz, 5260~5320 MHz, 5500~5700 MHz For 802.11n-HT40 5190~5230 MHz, 5270~5310 MHz, 5510~5670 MHz 802.11ac-VHT80: 5210 MHz, 5290 MHz, 5530 MHz, 5610 MHz;
Channel Number	802.11a/n-HT20/ac-VHT20: 19 802.11n-HT40/ac-VHT40: 9 802.11ac-VHT80: 4
Type of Modulation	802.11a/n/ac: OFDM
Data Rate	802.11a: 6/9/12/18/24/36/48/54Mbps 802.11n: up to 300Mbps 802.11ac: up to 866.6Mbps

Note: For other features of this EUT, test report will be issued separately.

1.6. Operation Frequency / Channel List

802.11a/n-HT20/ac-VHT20

Channel	Frequency	Channel	Frequency	Channel	Frequency
36	5180 MHz	40	5200 MHz	44	5220 MHz
48	5240 MHz	52	5260 MHz	56	5280 MHz
60	5300 MHz	64	5320 MHz	100	5500 MHz
104	5520 MHz	108	5540 MHz	112	5560 MHz
116	5580 MHz	120	5600 MHz	124	5620 MHz
128	5640 MHz	132	5660 MHz	136	5680 MHz
140	5700 MHz	--	--	--	--

802.11n-HT40/ac-VHT40

Channel	Frequency	Channel	Frequency	Channel	Frequency
38	5190 MHz	46	5230 MHz	54	5270 MHz
62	5310 MHz	102	5510 MHz	110	5550 MHz
118	5590 MHz	126	5630 MHz	134	5670 MHz

802.11ac-VHT80

Channel	Frequency	Channel	Frequency	Channel	Frequency
42	5210 MHz	58	5290 MHz	106	5530 MHz
122	5610 MHz	N/A	N/A	N/A	N/A

1.7. Description of Available Antennas

Antenna Type	Manufacturer	Tx Paths	Max Directional Gain (dBi)
Antenna 1#	Kunshan Wavelink Electronic Co., Ltd.	2	2.4GHz: 2.0, 5GHz: 2.0
Antenna 2#	TAOGLAS Inc	2	2.4GHz: 4.5, 5GHz: 6.7
Antenna 3#	Compex Systems Pte Ltd	2	2.4GHz: 5.0, 5GHz: 5.0
Antenna 4#	Compex Systems Pte Ltd	2	2.4GHz: 5.0, 5GHz: 5.0
Antenna 5#	Smart Ant Inc	2	5GHz: 7.0
Antenna 6#	Kenbotong Communication LTD	2	5GHz: 10.0
Antenna 7#	Sensor Systems, Inc.	2	2.4GHz: 8.0, 5GHz: 8.0

1.8. Standards Applicable for Testing

The EUT complies with the requirements of ETSI EN 301 893 V2.1.1.

1.9. Application Form for Testing

Device Type			
<input checked="" type="checkbox"/>	Stand-alone equipment		
<input type="checkbox"/>	Combined (or host) equipment		
<input type="checkbox"/>	Plug-in radio device		
<input type="checkbox"/>	Test Jig		
Operating Conditions			
<input checked="" type="checkbox"/>	AC Mains State AC Voltage: 100 - 240V	<input type="checkbox"/>	DC State DC Voltage: DC 48V
Type of DC Source		<input type="checkbox"/>	Internal power supply
		<input type="checkbox"/>	External power supply or AC/DC adapter
		<input type="checkbox"/>	Battery
<input checked="" type="checkbox"/>	Temperature Range: -20 ~ 70°C		
Antenna Category			
<input checked="" type="checkbox"/>	Integral antenna (antenna permanently attached)		
	<input checked="" type="checkbox"/>	Permanently RF connector provided (Specific Antenna Connectors)	
	<input type="checkbox"/>	No temporary RF connector provided	
Adaptivity (Channel Access Mechanism)			
<input type="checkbox"/> Frame Based Equipment			
<input checked="" type="checkbox"/> Load Based Equipment			
With Regards to Adaptivity for Frame Based Equipment			
<input type="checkbox"/> The Frame Based Equipment equipment operates as an Initiating Device			
<input type="checkbox"/> The Frame Based Equipment equipment operates as an Responding Device			
<input type="checkbox"/> The Frame Based Equipment equipment can operate as an Initiating Device and as a Responding Device			
With Regards to Adaptivity for Load Based Equipment			
<input type="checkbox"/> The Load Based Equipment equipment operates as a Supervising Device			
<input type="checkbox"/> The Load Based Equipment equipment operates as a Supervised Device			
<input checked="" type="checkbox"/> The Load Based Equipment can operate as a Supervising and as a Supervised Device			
<input type="checkbox"/> The Load Based Equipment equipment makes use of note 1 in table 7 or note 1 in table 8 of ETSI EN 301 893 V2.1.1			
<input type="checkbox"/> The Load Based Equipment equipment, when operating as a Supervising Device, makes use of note 2 in table 8 of ETSI EN 301 893 V2.1.1			
<input type="checkbox"/> The Load Based Equipment equipment operates as an Initiating Device			
<input type="checkbox"/> The Load Based Equipment equipment operates as an Responding Device			

<input checked="" type="checkbox"/> The Load Based Equipment equipment can operate as an Initiating Device and as a Responding Device	
The Priority Classes implemented by the Load Based Equipment	
<ul style="list-style-type: none"> ● When operating as a Supervising Device 	
<input type="checkbox"/> Priority Class 4 (Highest priority)	
<input type="checkbox"/> Priority Class 3	
<input type="checkbox"/> Priority Class 2	
<input checked="" type="checkbox"/> Priority Class 1 (Lowest priority)	
<ul style="list-style-type: none"> ● When operating as a Supervised Device 	
<input type="checkbox"/> Priority Class 4 (Highest priority)	
<input type="checkbox"/> Priority Class 3	
<input type="checkbox"/> Priority Class 2	
<input checked="" type="checkbox"/> Priority Class 1 (Lowest priority)	
With regard to Energy Detection Threshold, the Load Based Equipment has implemented either option 1 of clause 4.2.7.3.2.5 of ETSI EN 301 893 V2.1.1 or option 2 of clause 4.2.7.3.2.5 of ETSI EN 301 893 V2.1.1:	
<input checked="" type="checkbox"/> Option 1	<input type="checkbox"/> Option 2
Geo-location capability supported by the equipment	
<input type="checkbox"/>	Yes <input type="checkbox"/> The geographical location determined by the equipment is not accessible to the user.
<input checked="" type="checkbox"/>	No

2. Test Summary

Clause EN301893	Test Parameter	Result (Pass/Fail)	Remark
4.2.7	Adaptivity (Channel Access Mechanism)	Pass	--
4.2.8	Receiver Blocking	Pass	--

3. Adaptivity (Channel Access Mechanism)

3.1. Limit

This device define to Load Based Equipment.

Priority Class dependent Channel Access parameters for Supervised Devices				
Class #	p_0	CW_{min}	CW_{max}	Maximum Channel Occupancy Time (COT)
4	2	3	7	2ms
3	2	7	15	4ms
2	3	15	1023	6ms (note 1)
1	7	15	1023	6ms (note 1)

Note 1: The maximum Channel Occupancy Time (COT) of 6ms may be increased to 8ms by inserting one or more pauses. The minimum duration of a pause shall be 100 μ s. The maximum duration (Channel Occupancy) before including any such pause shall be 6ms. Pause duration is not included in the channel occupancy time.

Note 2: The values for p_0 , CW_{min} , CW_{max} are minimum values. Greater values are allowed.

Priority Class dependent Channel Access parameters for Supervising Devices				
Class #	p_0	CW_{min}	CW_{max}	Maximum Channel Occupancy Time (COT)
4	1	3	7	2ms
3	1	7	15	4ms
2	3	15	1023	6ms (note 1)
1	7	15	1023	6ms (note 1)

Note 1: The maximum Channel Occupancy Time (COT) of 6 ms may be increased to 8 ms by inserting one or more pauses. The minimum duration of a pause shall be 100 μ s. The maximum duration (Channel Occupancy) before including any such pause shall be 6ms. Pause duration is not included in the channel occupancy time.

Note 2: The maximum Channel Occupancy Time (COT) of 6 ms may be increased to 10 ms by extending CW to $CW \times 2 + 1$ when selecting the random number q for any backoff(s) that precede the Channel Occupancy that may exceed 6 ms or which follow the Channel Occupancy that exceeded 6ms. The choice between preceding or following a Channel Occupancy shall remain unchanged during the operation time of the device.

Note 3: The values for p_0 , CW_{min} , CW_{max} are minimum values. Greater values are allowed.

For equipment that for its operation in the 5 GHz bands is conforming to IEEE 802.11™ac-2013 [10], clause 22, or to IEEE 802.11™-2012 [9], clause 18 or clause 20, or any combination of these clauses, the Energy Detect Threshold (ED Threshold) is independent of the equipment's maximum transmit power (PH). The Energy Detect Threshold (ED Threshold) shall be: TL = -75 dBm/MHz

Short Control Signalling Transmissions Limit

The use of Short Control Signalling Transmissions is constrained as follows:

- within an observation period of 50 ms, the number of Short Control Signalling Transmissions by the equipment shall be equal to or less than 50; and
- the total duration of the equipment's Short Control Signalling Transmissions shall be less than 2 500 μs within said observation period.

3.2. Test Setup

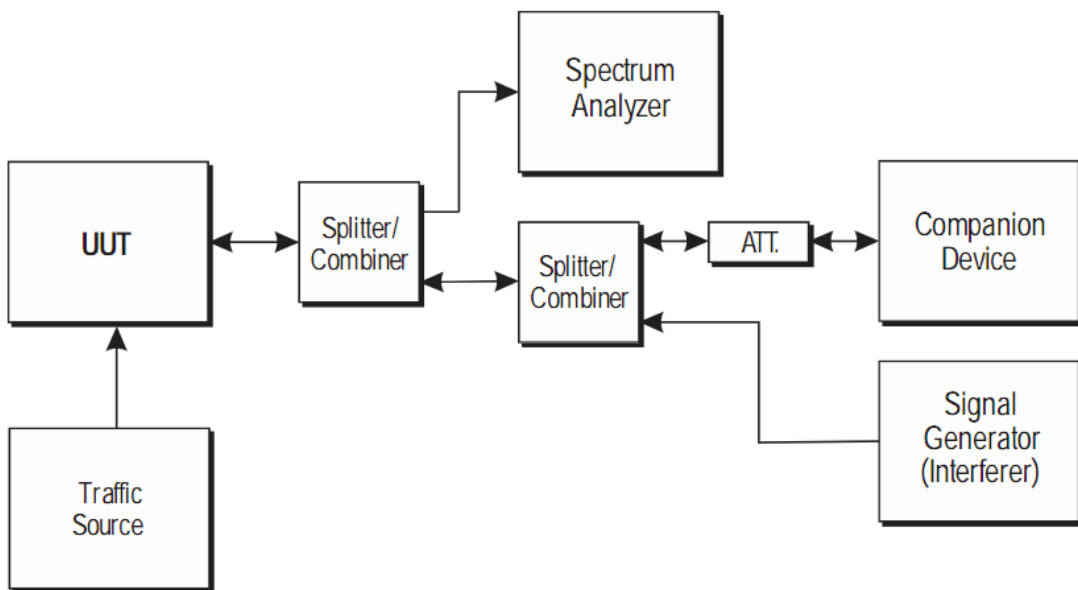

3.3. Test Procedure

Refer to Draft ETSI EN 301 893 V2.1.1 (2017-05) Clause 5.4.9.3.2.3.2

3.4. Test Result

Product	802.11ac Dual Band Module	Temperature	26°C
Test Engineer	Andy Zhu	Relative Humidity	54%
Test Site	TR4	Test Date	2017/07/07

AWGN Interference Signal Calibration - 5500MHz

Step 1 - Occupied Channel bandwidth

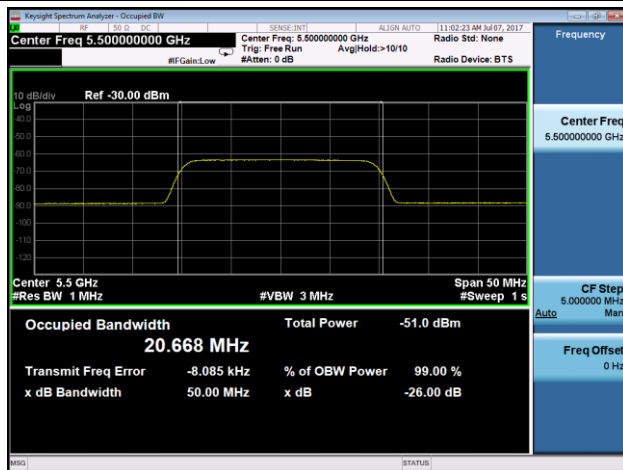

Step 2 - Interference Signal Level

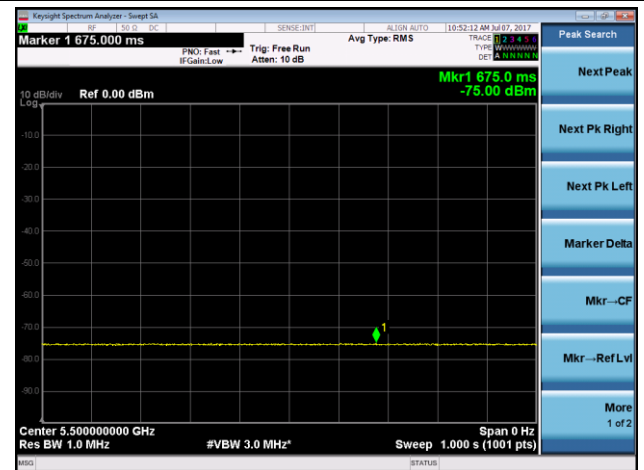

AWGN Interference Signal Calibration - 5520MHz

Step 1 - Occupied Channel bandwidth

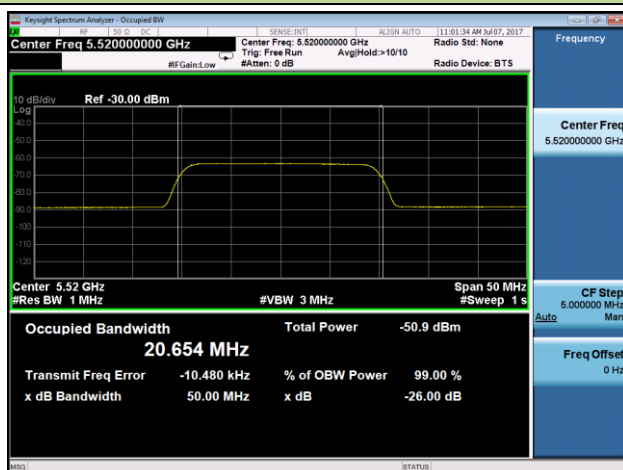

Step 2 - Interference Signal Level

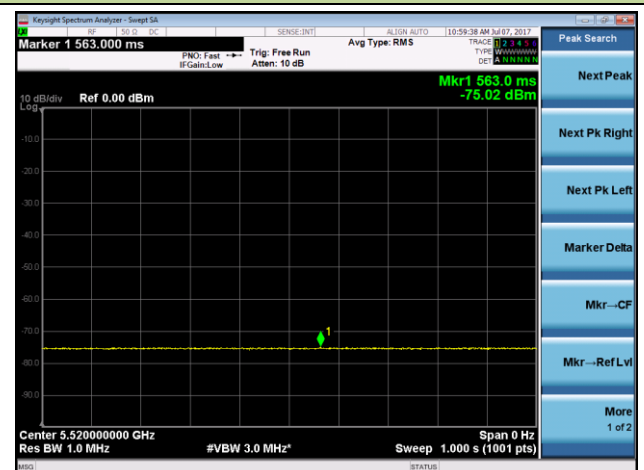

OFDM Interference Signal Calibration

Step 1 - Occupied Channel bandwidth

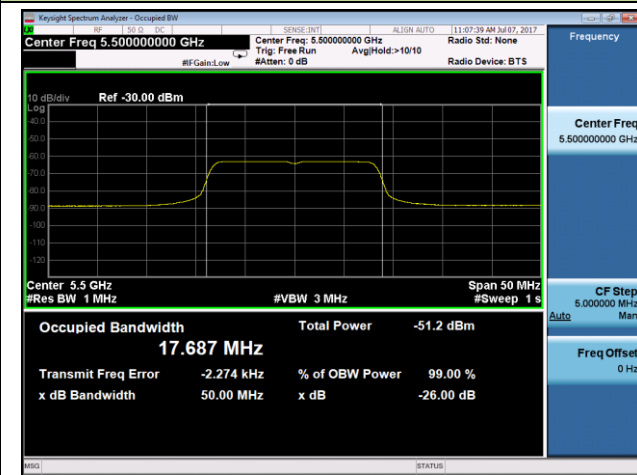

Step 2 - Interference Signal Level

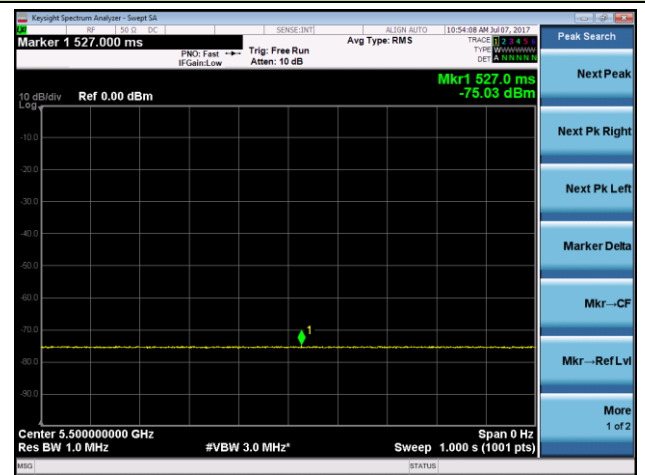

LTE Interference Signal Calibration

Step 1 - Occupied Channel bandwidth

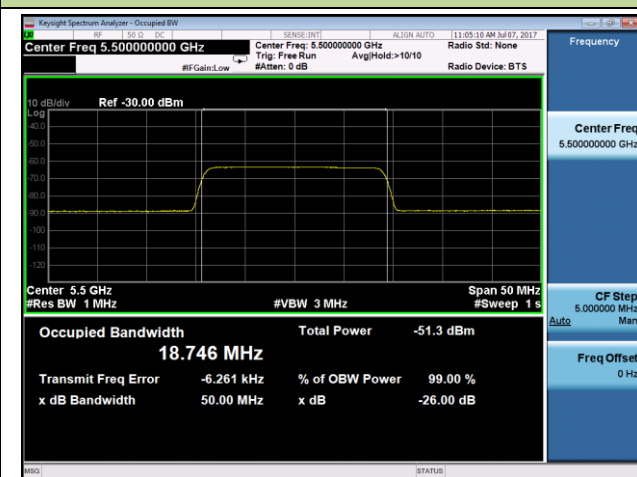

Step 2 - Interference Signal Level

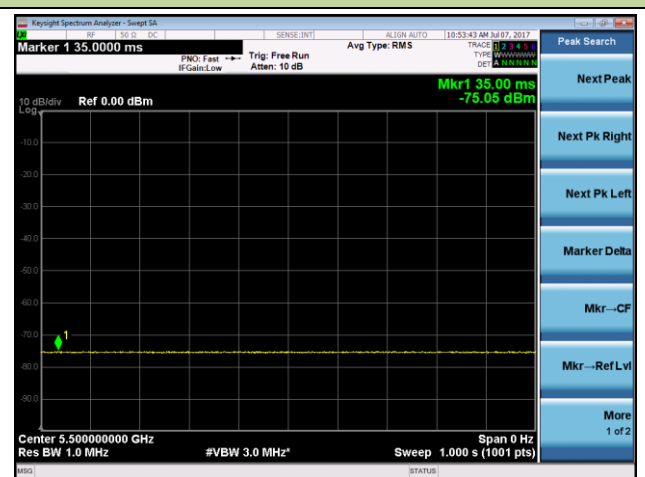

802.1a - 5500MHz

Maximum Channel Occupancy Time = 2.073ms

Minimum Idle Period = 154.9µs

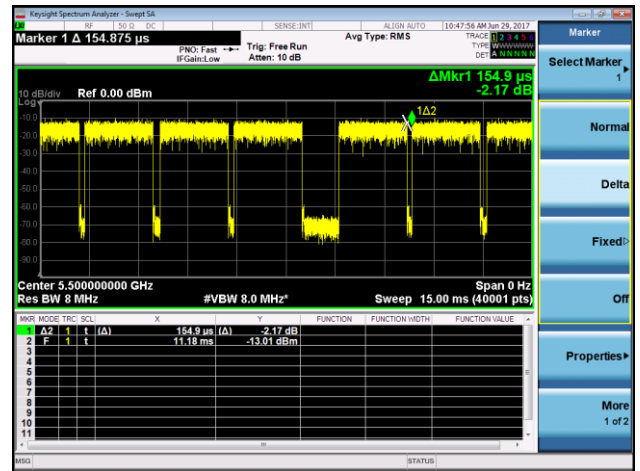
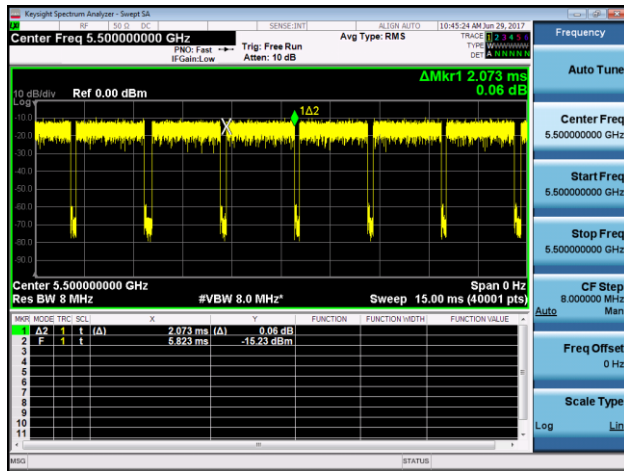

Transmission stopped after AWGN interference added

Transmission stopped after OFDM interference added

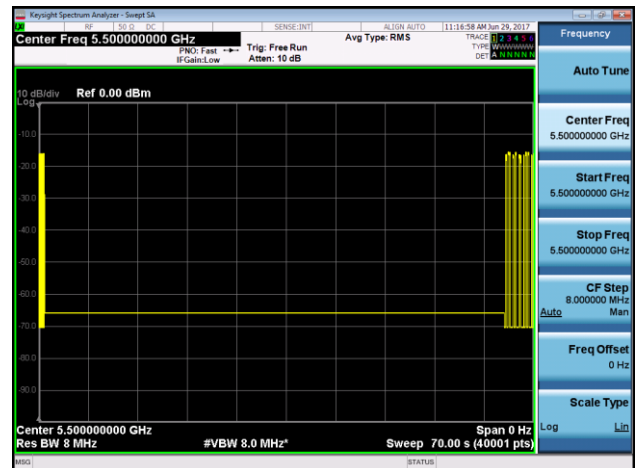
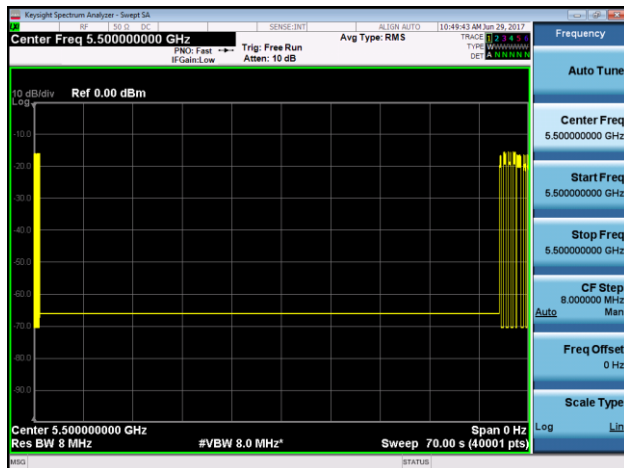

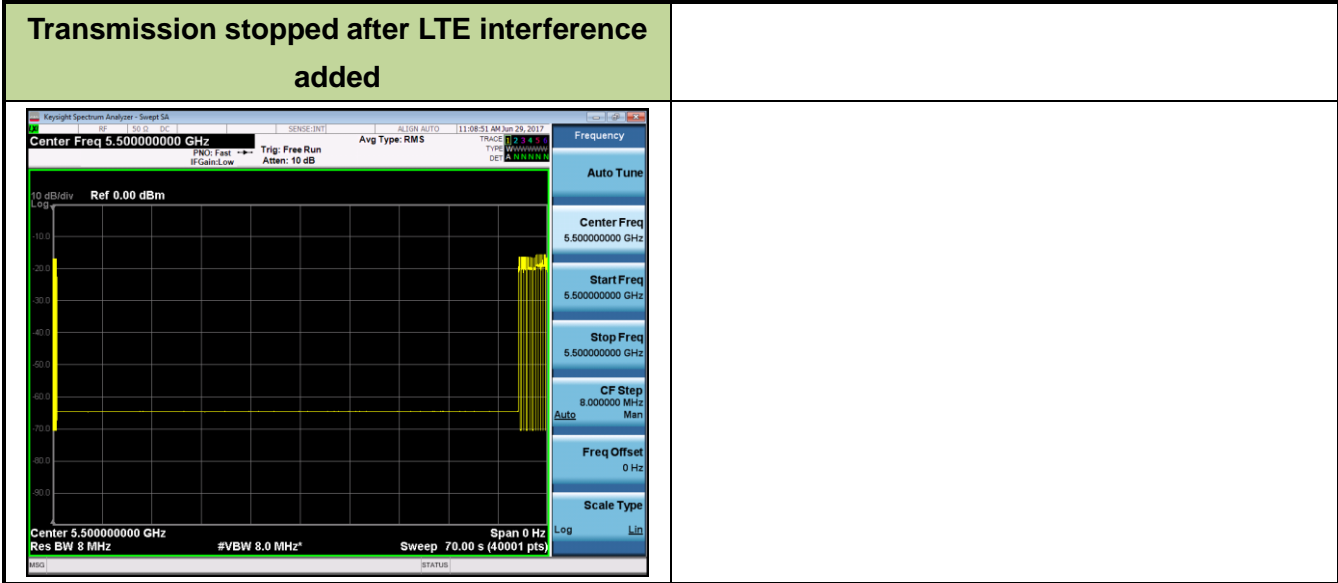

Note 1: Detection Level = -75 dBm/MHz.

Note 2: The manufacturer is allowed to declare compliance with the Medium Access Mechanism requirements contained in EN 301 893 V2.1.0 clause 4.2.7.3.2.6 and clause 4.2.7.3.2.7

Test Result:	Pass
---------------------	------

802.11n-HT40 - 5510MHz (Non-Primary Operating Channel)

Maximum Channel Occupancy Time = 3.328ms

Minimum Idle Period = 346.5µs

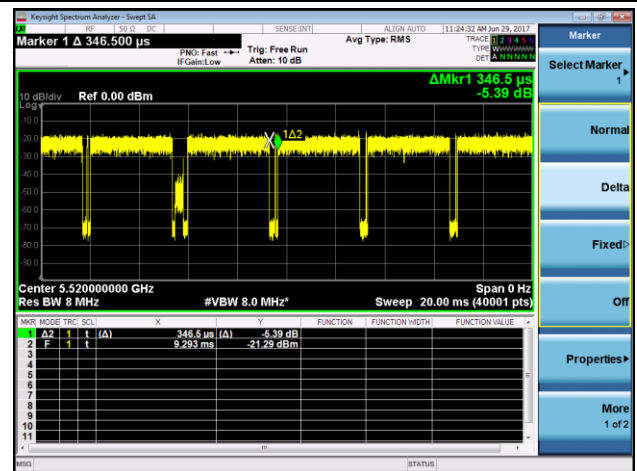
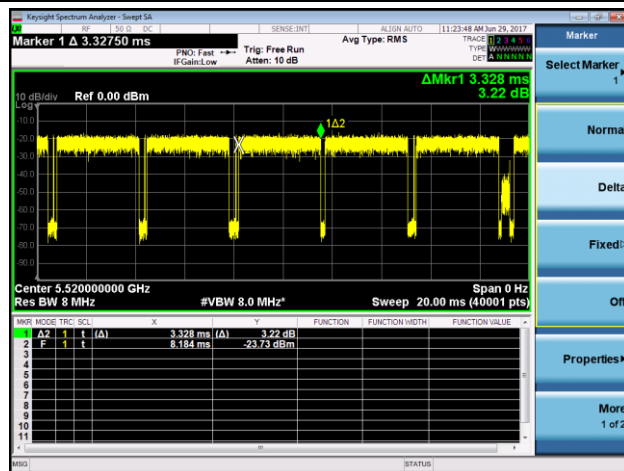

Transmission stopped after AWGN interference added

The total short control signaling less than 2.5ms within observation period

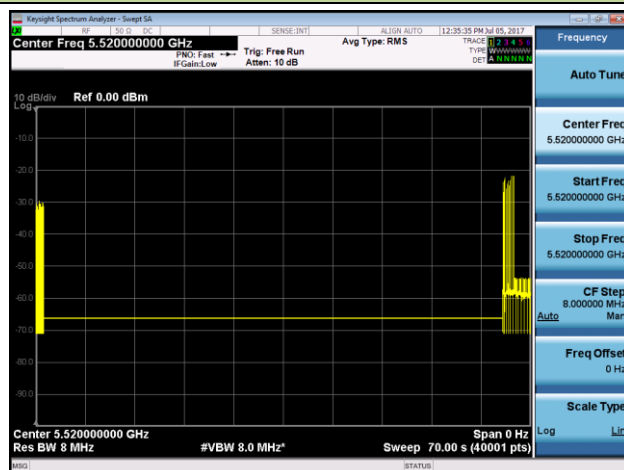

Note 1: Detection Level = -75 dBm/MHz.

Note 2: The manufacturer is allowed to declare compliance with the Medium Access Mechanism requirements contained in EN 301 893 V2.1.0 clause 4.2.7.3.2.6 and clause 4.2.7.3.2.7

Test Result:

Pass

802.11ac-VHT40 - 5510MHz (Non-Primary Operating Channel)

Maximum Channel Occupancy Time = 356.1us

Minimum Idle Period = 211.1us

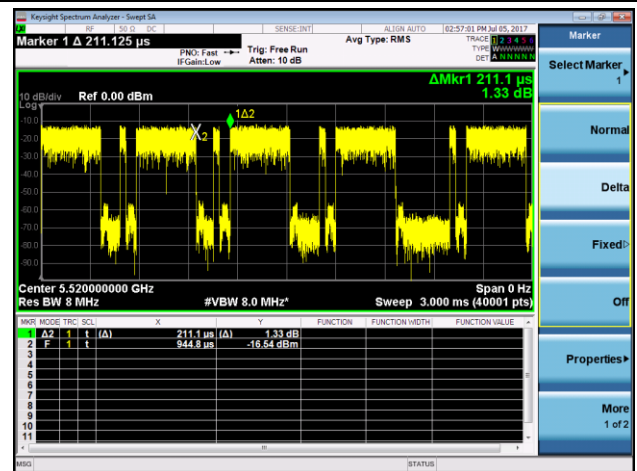
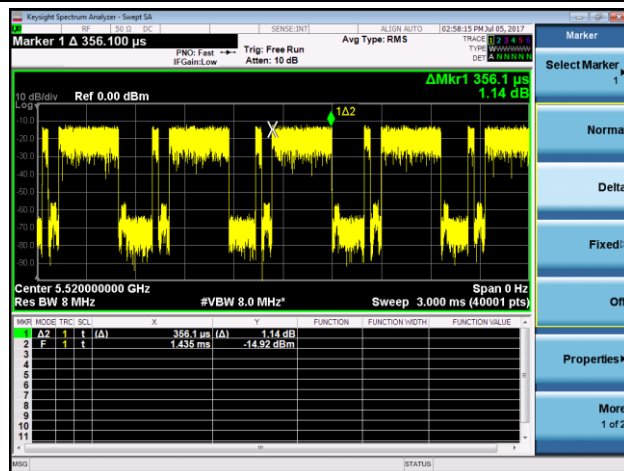

Transmission stopped after AWGN interference added

The total short control signaling less than 2.5ms within observation period

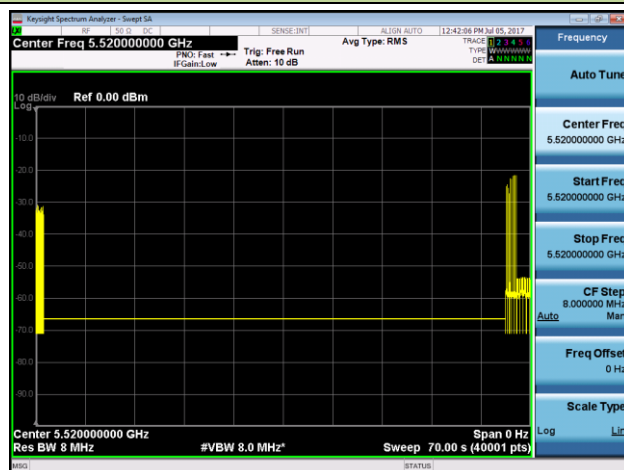

Note 1: Detection Level = -75 dBm/MHz.

Note 2: The manufacturer is allowed to declare compliance with the Medium Access Mechanism requirements contained in EN 301 893 V2.1.0 clause 4.2.7.3.2.6 and clause 4.2.7.3.2.7

Test Result:

Pass

4. Receiver Blocking

4.1. Limit

The minimum performance criterion shall be a PER less than or equal to 10 %. The manufacturer may declare alternative performance criteria as long as that is appropriate for the intended use of the equipment.

4.2. Test Setup

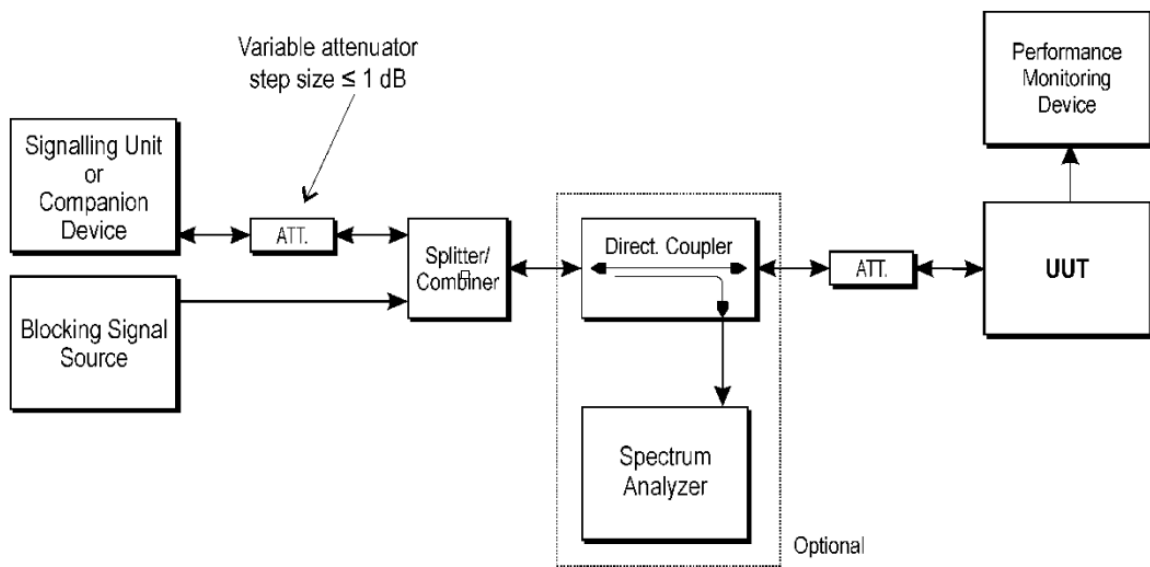

Test Set-up for receiver blocking

4.3. Test Procedure

Refer to ETSI EN 301 893 V2.1.1 (2017-03) Clause 5.4.10.2.1

4.4. Test Result

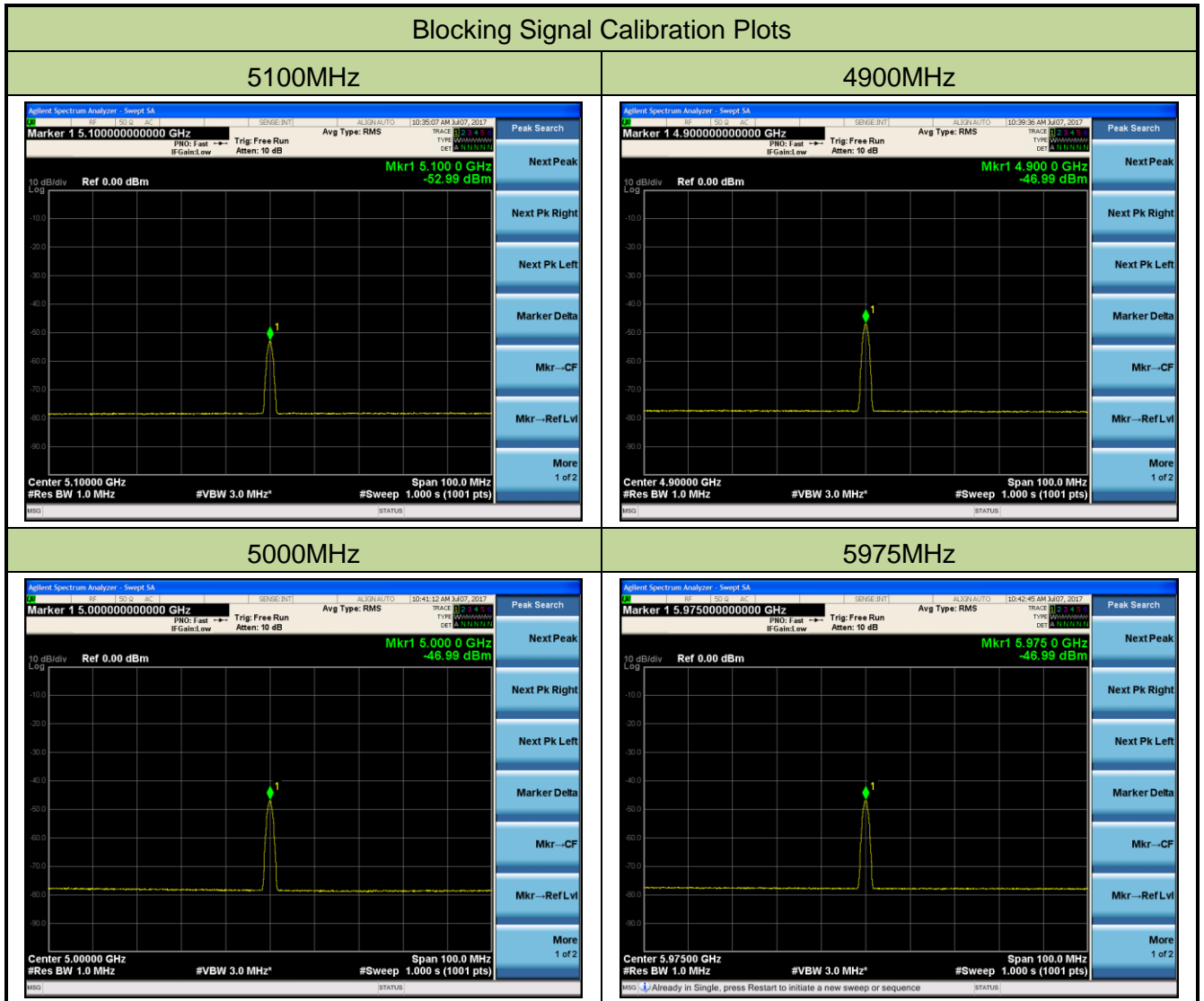

Product	WIRELESS ACCESS POINT	Temperature	26°C
Test Engineer	Andy Zhu	Relative Humidity	54%
Test Site	TR4	Test Data	2017/07/07
Test Mode	802.11a		

Channel	Wanted Signal Mean Power from Companion Device (dBm)	Blocking Signal Frequency (MHz)	Blocking Signal Power (dBm)	Type of Blocking Signal	PER Test Result	Limit (PER)	Test Result
64	$P_{\min} + 6 \text{ dB}$	4900	-47	CW	0.6	< 10%	Pass
		5000	-47		0.9		Pass
		5100	-53		0.5		Pass
		5975	-47		1.0		Pass

Note 1: the P_{\min} of channel 64 is -87dBm.

100	$P_{\min} + 6 \text{ dB}$	4900	-47	CW	0.5	< 10%	Pass
		5000	-47		0.8		Pass
		5100	-53		0.4		Pass
		5975	-47		0.5		Pass

Note 2: the P_{\min} of channel 100 is -87dBm.

5. Measurement Uncertainty

Where relevant, the following measurement uncertainty levels have been estimated for tests performed on the apparatus:

Parameter	Uncertainty
Radio Frequency	± 10 ppm
RF output power, conducted	± 1.5 dB
Power Spectral Density, conducted	± 3 dB
Spurious Emissions, radiated	± 6 dB
Temperature	± 2 °C
Humidity	± 5 %
Time	± 10 %

6. List of Measuring Instrument

Adaptivity (Channel Access Mechanism) - TR3

Instrument	Manufacturer	Type No.	Asset No.	Cali. Interval	Cali. Due Date
Spectrum Analyzer	Agilent	N9020A	MRTSUE06106	1 year	2018/04/25
Vector Signal Generator	Agilent	E4438C	MRTSUE06026	1 year	2017/12/08
Directional Coupler	Narda	4216-20	MRTSUE06065	1 year	2018/03/28
Power Splitter	Mini-Circuits	ZFRSC-123-S+	MRTSUE06122	N/A	N/A
Temperature/Humidity Meter	Yuhuaze	HTC-2	MRTSUE06180	1 year	2017/12/20

Receiver Blocking - TR3

Instrument	Manufacturer	Type No.	Serial No.	Cali. Interval	Cali. Due Date
Vector Signal Generator	Agilent	E4438C	MRTSUE06026	1 year	2017/12/06
4 Ch. Simultaneous Sampling 14	Agilent	U2531A	MRTSUE06247	N/A	N/A
4 Ch. Simultaneous Sampling 14	Agilent	U2531A	MRTSUE06248	N/A	N/A
Wideband Radio Communication Tester	R&S	CMW 500	MRTSUE06108	1 year	2017/11/10
Directional Coupler	Narda	4216-20	MRTSUE06065	1 year	2018/03/28
Power Splitter	Mini-Circuits	ZFRSC-123-S+	MRTSUE06122	N/A	N/A
Temperature/Humidity Meter	Yuhuaze	HTC-2	MRTSUE06180	1 year	2017/12/20

Software	Version	Function
e3	V8.3.5	EMI Test Software